



DELTA



DELTA SIGNAGE LINE

Consultation, Design Services, Engineering, Fabrication, Installation.

www.sd-ind.com | sales@sd-ind.com | 212-348-8000



DELTA SIGNAGE LINE

01

DELTA SIGNAGE LINE

FLOATING CLARITY, MODULAR IDENTITY

Delta is a modular signage system designed for clean integration, accessibility, and adaptability. Its distinctive feature is a set of aluminum side bars that suspend each sign slightly off the wall, creating a floating effect that enhances both visibility and elegance. The soft-rounded corners and clean typography ensure approachability and universal legibility.

Delta brings a contemporary look to wayfinding, ideal for professional environments such as hospitals, universities, offices, and civic institutions.

DELTA SIGNAGE LINE

ADA SIGNS

Key Features

Modular Format:

Designed to accommodate a wide range of sign types — from room IDs to directories and amenities — using a standardized base that simplifies manufacturing and installation.

Floating Mounting System:

Aluminum bars on each side elevate the signage from the surface, producing a subtle shadow gap and a sense of visual lightness.

Tactile and ADA-Compliant:

All models include integrated braille and raised text, meeting international accessibility standards.

Rounded Corners for Safety and Softness:

The softened geometry gives each piece a more human, less institutional presence while avoiding sharp edges in high-contact areas.

Color Versatility with Durable Finishes:

Available in customizable colors with matte anti-glare finishes suited for both interior and exterior use.

Consistent Visual Language Across Functions:

Delta includes room IDs, directional signs, bathroom identifiers, occupancy indicators, and floor markers — all unified by proportions, typography, and materials.



DELTA SIGNAGE LINE
ADA SIGNS

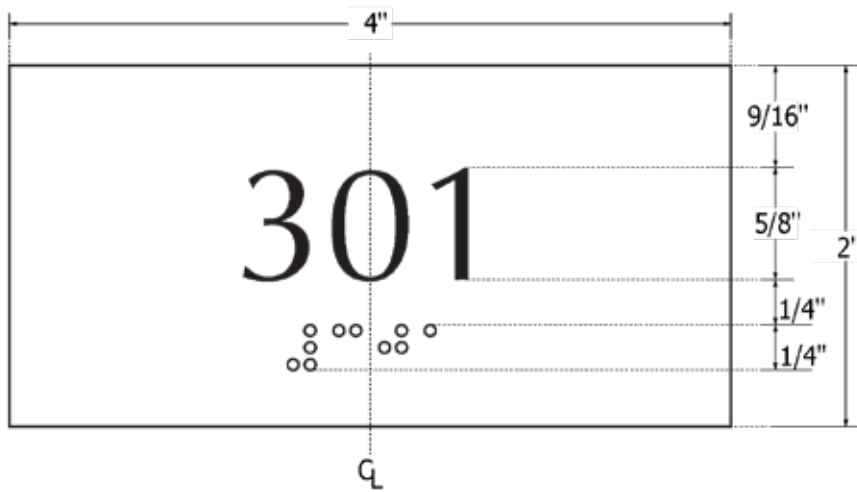

DELTA A-1

03

A-1: ROOM ID SIGN

The Delta A-1 is a compact, minimalist room identification sign designed for clarity, accessibility, and ease of installation. It features a horizontally oriented rectangular plate with rounded corners and a matte surface that minimizes glare. White raised text and Grade 2 Braille provide clear, tactile information. Two vertical aluminum side bars create a floating effect, subtly separating the sign from the wall and reinforcing Delta’s modular visual identity.

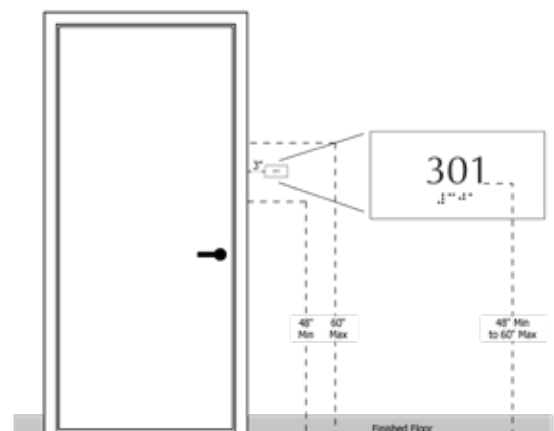

DELTA SIGNAGE LINE
ADA SIGNS



DELTA A-2

04

A-2: ROOM ID SIGN

The Delta A-2 sign combines numeric room identification with a clearly labeled room function, providing intuitive wayfinding for both staff and visitors. Its horizontal layout accommodates both elements without overcrowding, maintaining the clean, modular look of the Delta line. The faceplate is framed by floating aluminum side bars, giving the sign a refined, lightweight presence on the wall.

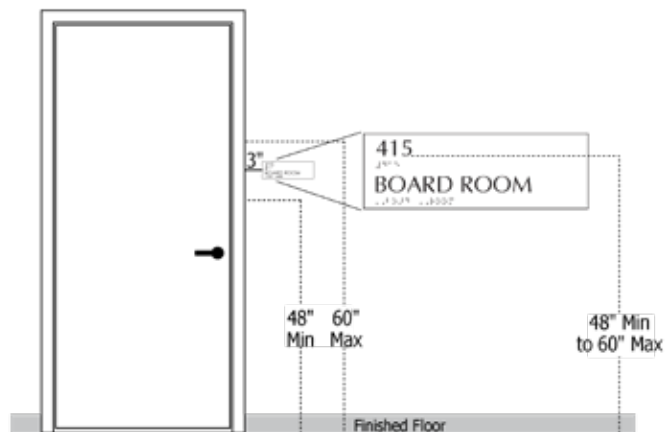

DELTA SIGNAGE LINE
ADA SIGNS

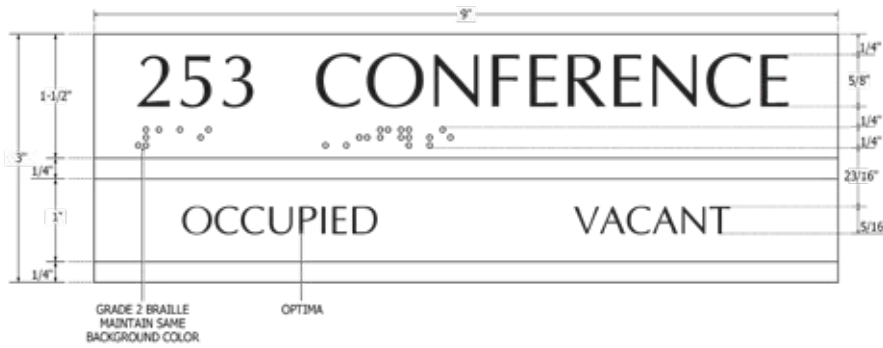

DELTA A-3

05

A-3: OCCUPIED / VACANT TOGGLE

The Delta A-3 sign integrates essential room identification with a manual occupancy slider, providing a clear and intuitive status display. Whether VACANT or OCCUPIED, the status is instantly visible through a contrasting reveal window located at the bottom of the sign.

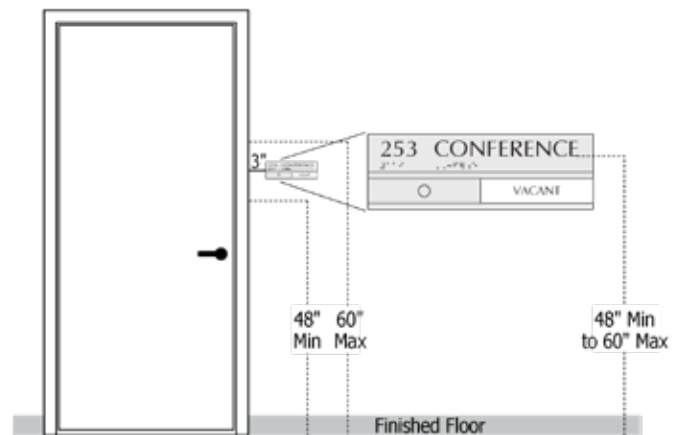

DELTA SIGNAGE LINE
ADA SIGNS



DELTA A-4

06



A-4: ROOM ID SIGN

The Delta A-4 sign is designed to identify shared or transitional spaces like waiting rooms, lounges, or reception areas. It pairs a discrete room number with a prominently displayed function name, making it immediately clear what purpose the space serves.

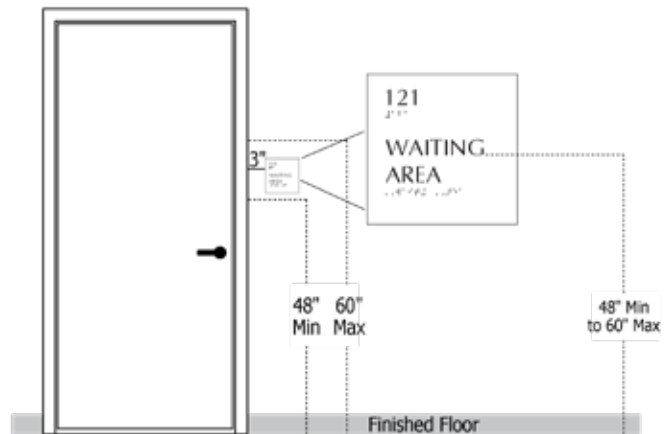

DELTA SIGNAGE LINE
ADA SIGNS



A-5: ROOM ID SIGN

The Delta A-5 sign is tailored for identifying rooms associated with departments, services, or specialized units. It divides information into two clear sections: a top panel for the room number and a larger lower panel for the department or function name.

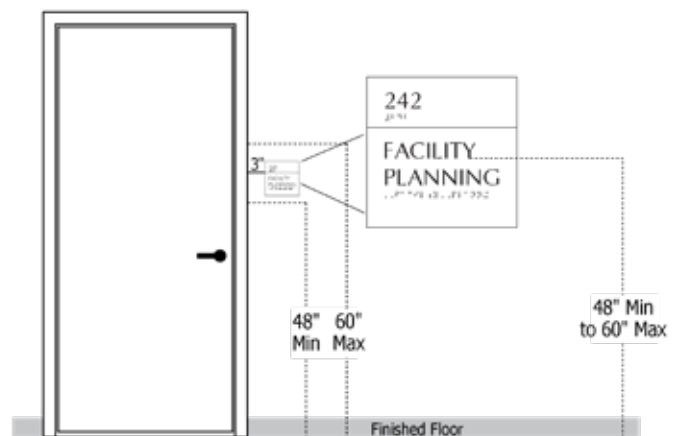

DELTA SIGNAGE LINE
ADA SIGNS

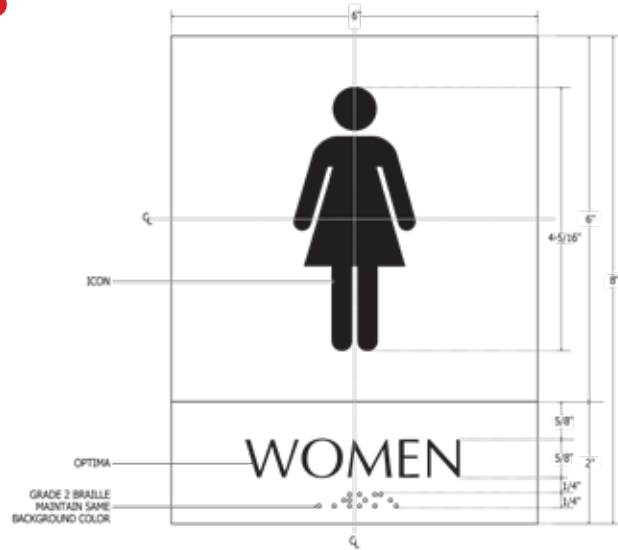

DELTA A-6

08



A-6: BATHROOM ID SIGN

The Delta A-6 sign is purpose-built for restroom identification, combining visual icons, text, and tactile elements in a compact vertical format. A universally recognized pictogram is positioned prominently above the label, making the sign immediately legible from a distance.

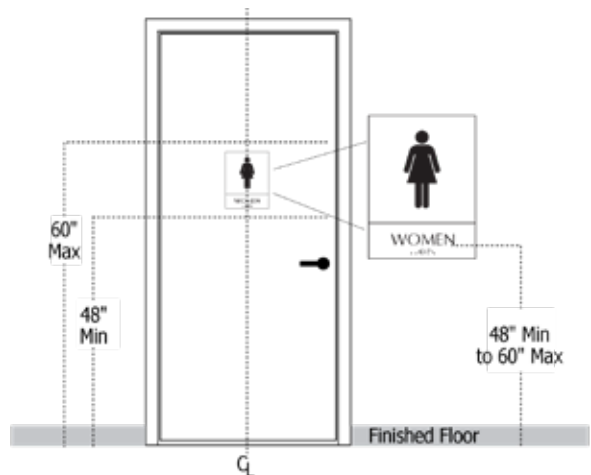

DELTA SIGNAGE LINE
ADA SIGNS

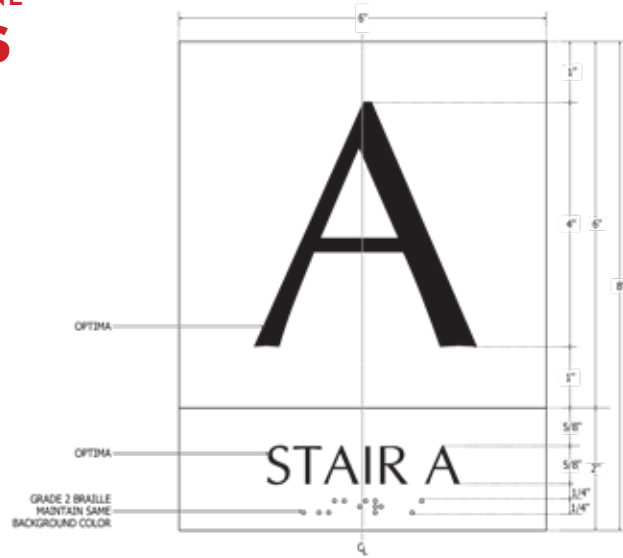

DELTA A-7

09



A-7: STAIR ID SIGN

The Delta A-7 sign clearly marks stairwells with a bold, oversized alphanumeric identifier supported by a secondary text label. This sign ensures quick recognition and orientation in both everyday use and emergency situations.

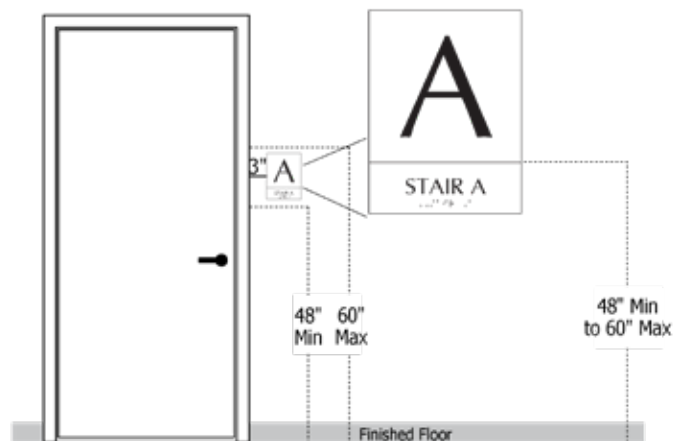

DELTA SIGNAGE LINE
ADA SIGNS



DELTA A-8

10

A-8: FLOOR ID SIGN

The Delta A-8 sign is a dedicated floor marker designed for high visibility and compliance in vertical circulation areas such as stairwells, elevator lobbies, and hallway intersections. Its layout emphasizes the floor number with oversized, centered typography, supported by a secondary "FLOOR" label for clarity and accessibility.

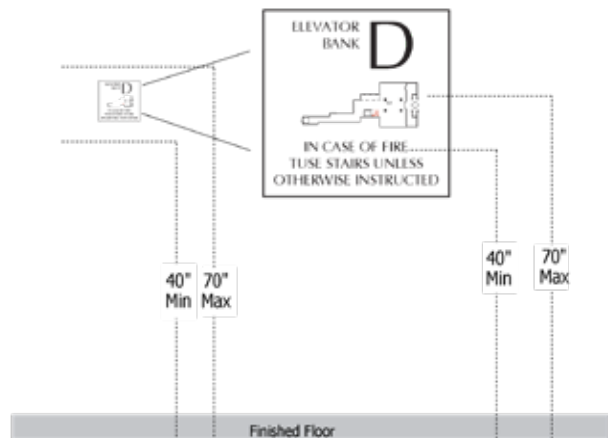

DELTA SIGNAGE LINE

ADA SIGNAGE W/ FLEX OPTION

The Delta ADA Flex model is a versatile signage solution that combines permanent ADA-compliant identification with the flexibility of changeable paper inserts. Designed for dynamic environments, it allows users to update names, functions, or room assignments without replacing the full sign.

The system features horizontal slats with clear cover channels for paper or card inserts, framed by aluminum top and bottom brackets that maintain the Delta line's floating aesthetic. A fixed top panel contains tactile text and Braille for code compliance.

Key Features

Permanent + Changeable Info:

Static ADA section ensures accessibility while insertable strips accommodate evolving content like staff names for temporary uses, or department changes.

Paper Insert Slots:

Multiple horizontal channels support printed or hand-written labels protected by transparent covers.

ADA Compliance:

Braille and raised text on the header meet accessibility regulations and maintain legibility.



DELTA ADA FLEX

11

DELTA SIGNAGE LINE
ADA SIGNAGE FLEX

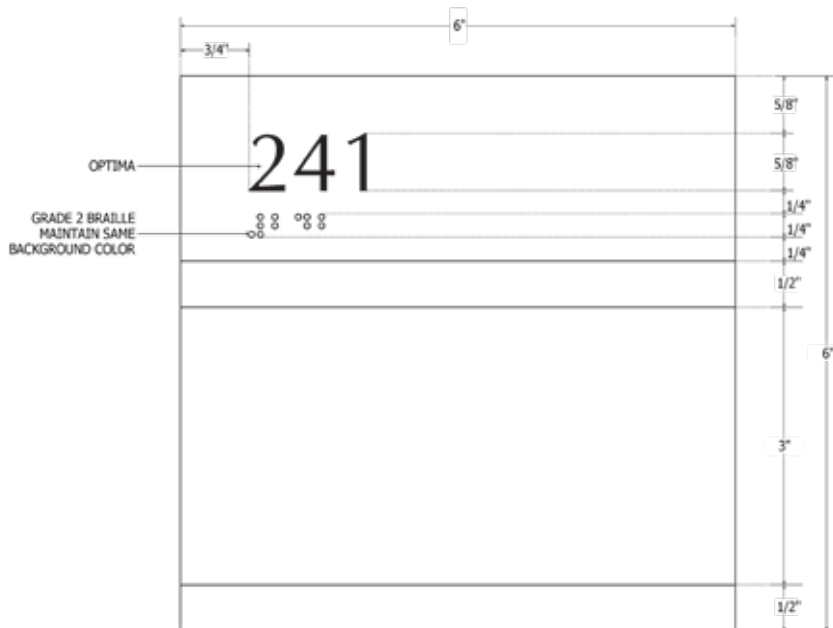

DELTA B-1

12



**B-1: ROOM ID
 WITH PAPER INSERT**

The Delta B-1 sign offers a practical combination of permanence and flexibility. Designed for individual offices, classrooms, or consulting rooms, this model features a fixed top section with the room number in tactile and Braille formats, along with a changeable paper insert window below.

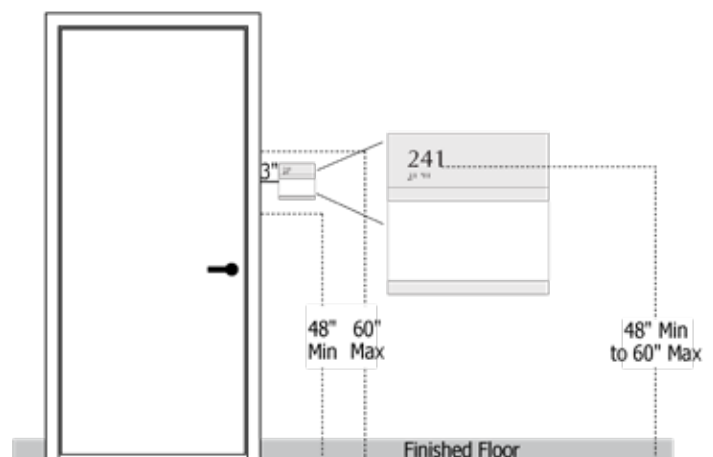

DELTA SIGNAGE LINE
ADA SIGNAGE FLEX

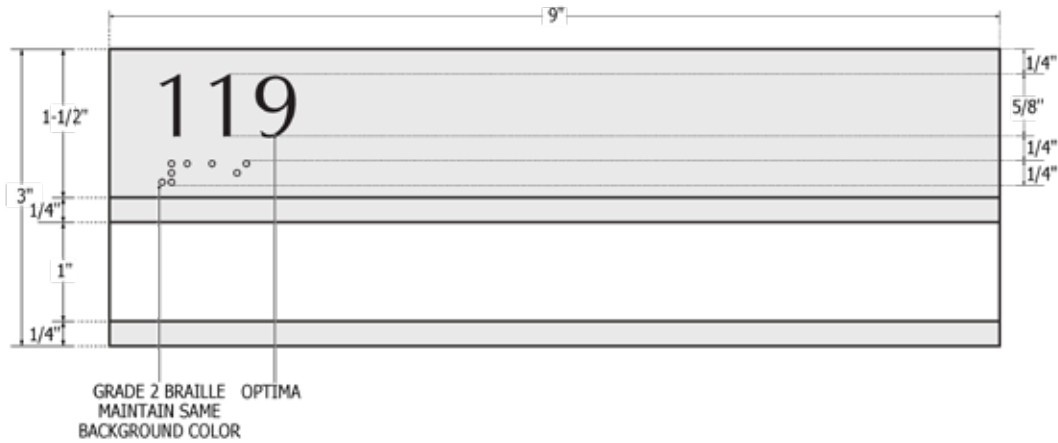

DELTA B-2

13

**B-2: ROOM ID
 WITH PAPER INSERT**

The B-2 sign offers horizontal room identification with space for a full-width paper insert. Its streamlined proportions make it ideal for longer names or titles without sacrificing accessibility or elegance.

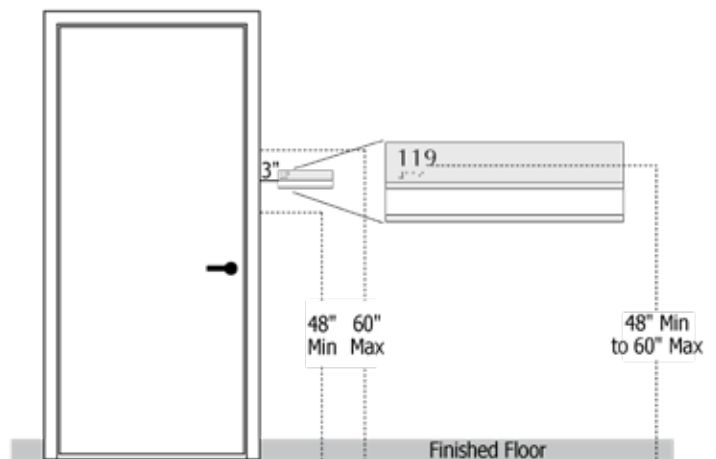

DELTA SIGNAGE LINE
ADA SIGNAGE FLEX

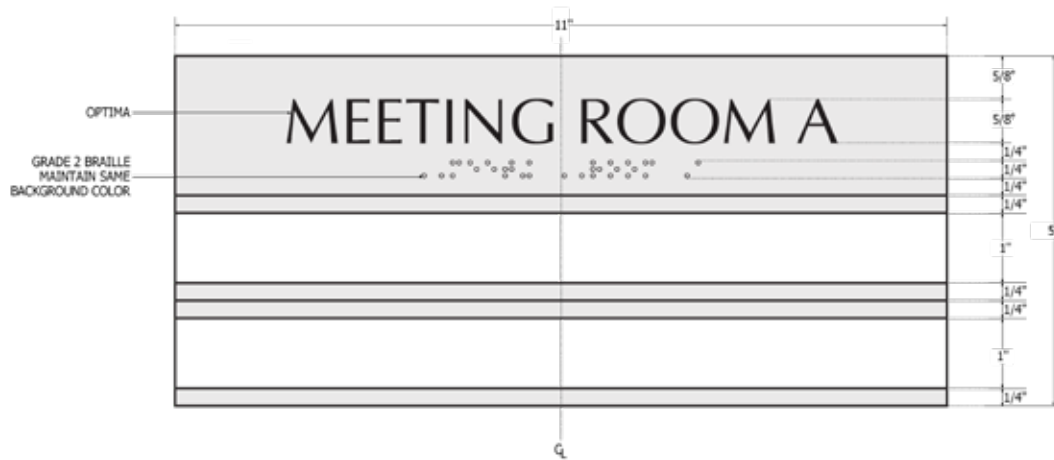

**B-3: ROOM ID
WITH PAPER INSERT**

B-3 is a horizontal room ID sign designed for shared or dynamic spaces like meeting rooms. It features a permanent room name in tactile lettering and braille, along with two paper insert slots for flexible scheduling or occupancy details.

DELTA B-3

14

DELTA SIGNAGE LINE

ADA SIGNAGE FLEX

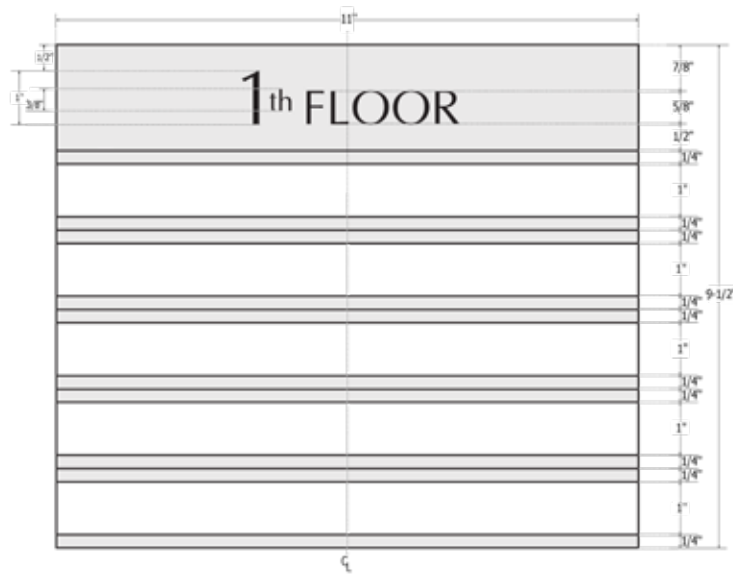

DELTA B-4

15

B-4: ROOM ID WITH PAPER INSERT

B-4 is a modular floor directory sign designed for high-traffic or multi-room areas. It features a fixed floor identifier and six paper insert slots for listing departments, offices, or room occupants. Ideal for lobbies, elevator areas, or building cores.

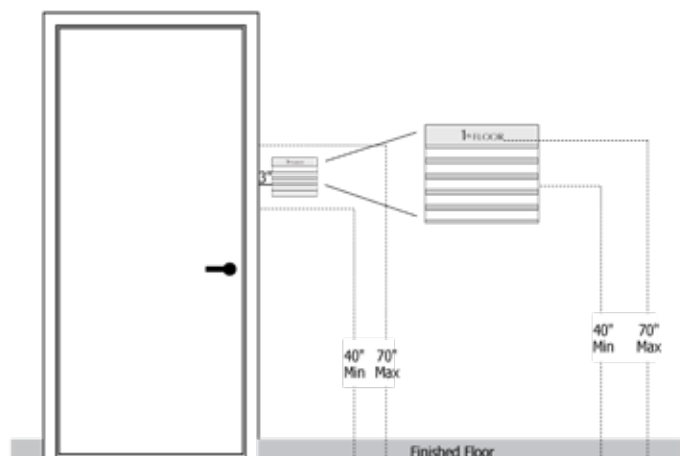

DELTA SIGNAGE LINE
ADA SIGNAGE FLEX

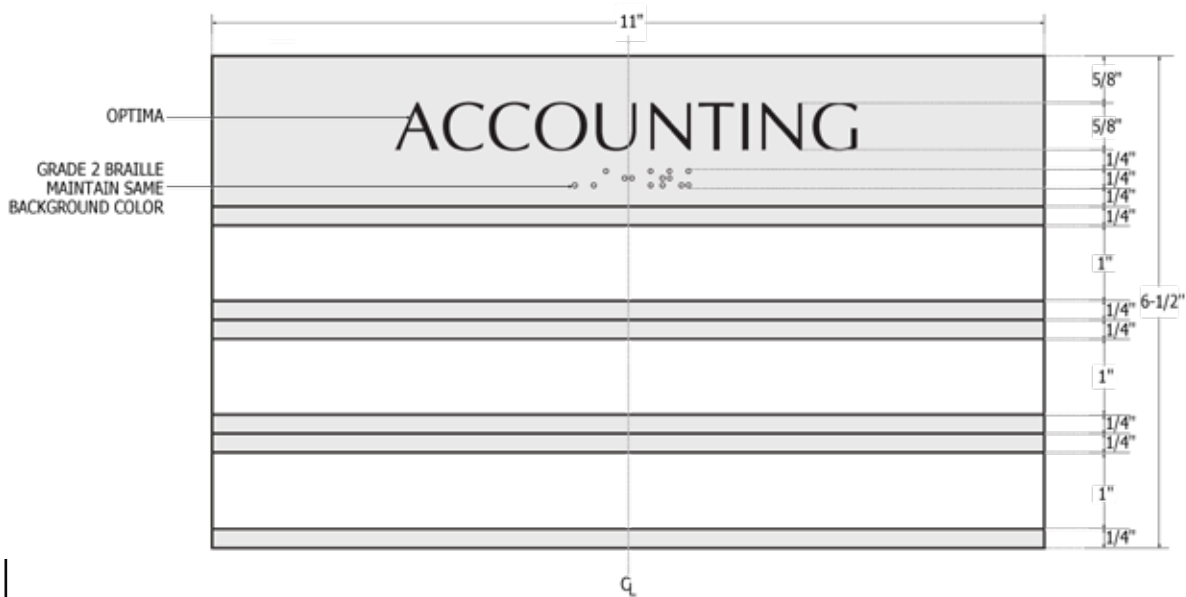

DELTA B-5

16

B-5: ROOM ID WITH PAPER INSERT

B-5 is a versatile room identification sign that pairs a fixed department or room name with four interchangeable paper insert slots. Designed for spaces with rotating staff or changing functions, this sign provides clarity and adaptability for dynamic environments.

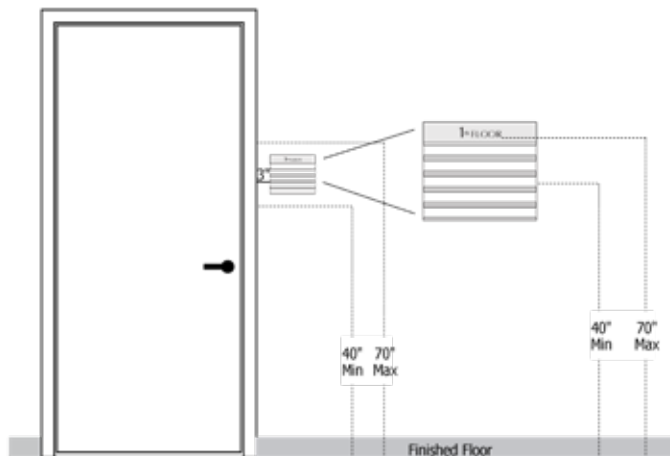

DELTA SIGNAGE LINE

FLOOR DIRECTIONAL AND WAYFINDING

The Directories and Wayfinding Panels in the Basic Sign System simplify navigation in busy interior spaces. With clean layouts, clear arrows, and flexible content options, they help users find rooms or departments quickly. Ideal for multi-tenant and public buildings, each panel is modular, easy to read, and simple to update when changes occur.

Key Features:

Standardized Layouts:

Designed to be immediately readable, with directional cues and floor identifiers in a consistent format.

Flexible Content Structure:

Supports ranges of room numbers, department names, or company names — accommodating both public and private building types.

Update-Friendly Panels:

Select models include replaceable inserts or modular slats to allow quick tenant or room number changes without replacing the whole sign.

Space-Efficient Design:

Horizontal panel stacking ensures clarity without overwhelming the viewer — even when listing many destinations.



DELTA SIGNAGE LINE

FLOOR DIRECTIONAL AND WAYFINDING

DELTA C-1



18

C-1: FLOOR DIRECTORY NAMES

C-1 is a floor-level directional sign designed to guide visitors through complex interior layouts with clarity and ease. It displays the floor number prominently, followed by a list of destinations and directional arrows for immediate spatial orientation.

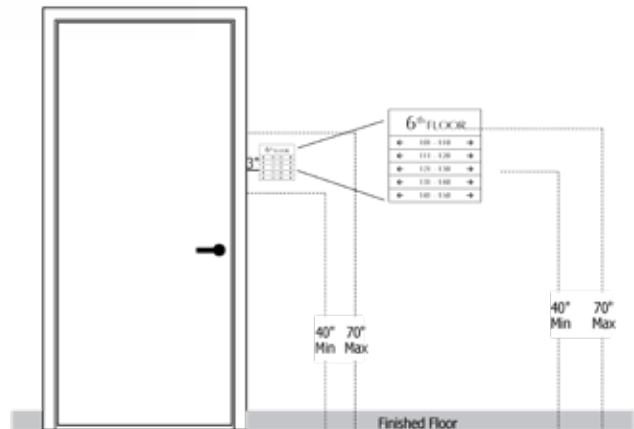

DELTA SIGNAGE LINE

FLOOR DIRECTIONAL AND WAYFINDING

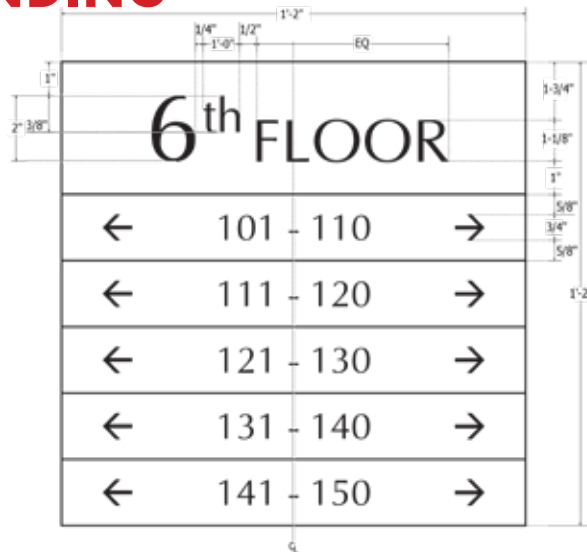

DELTA C-2

19

C-2: FLOOR DIRECTORY NUMBERS

C-2 is a structured directional sign designed to display room number ranges by floor, with accompanying arrows for navigation. Ideal for building lobbies and elevator landings, it helps users locate rooms quickly and intuitively.

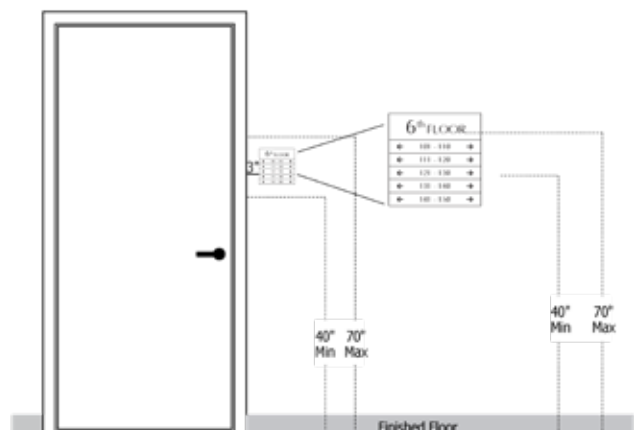

DELTA SIGNAGE LINE

FLOOR DIRECTIONAL AND WAYFINDING



DELTA C-3

20

C-3 : EGRESS MAP

C-3 is a Wall-mounted egress map designed to support safety and orientation. Placed near elevator lobbies and major circulation points, it provides a clear path to exits in emergencies and reinforces wayfinding through graphic and textual cues.

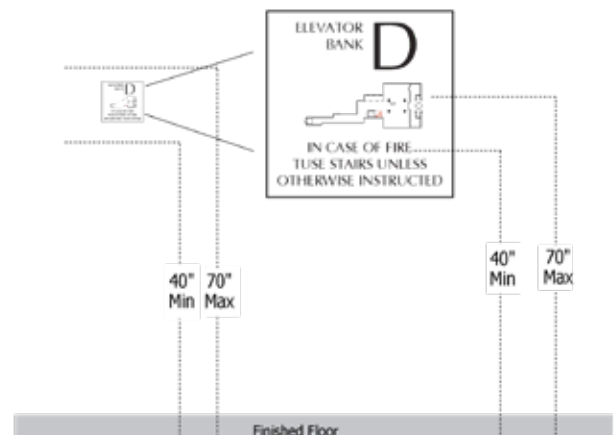

DELTA SIGNAGE LINE

PYLONS & DIRECTORIES

The Cyber pylons and directories are bold wayfinding anchors designed to organize and direct movement in large-scale environments. With sharp silhouettes, dark finishes, and high-contrast graphic panels, these freestanding elements echo the architectural language of the Cyber line—futuristic, functional, and visually assertive.

Ideal for malls, campuses, office complexes, and transit hubs, each unit offers a clear hierarchy of information while maintaining a sleek, high-tech presence in the public realm.

Key Features

Angular Monolithic Form:

The base geometry features crisp, faceted planes that break away from traditional boxy pylons. This sculptural approach enhances visibility and adds architectural value.

Modular Display Zones:

Options include static directories, dynamic digital panels, or interchangeable tenant panels. Each is framed cleanly within a bold profile for maximum legibility.

High Contrast and Readability:

Whether showcasing building maps, tenant listings, or area directories, every panel uses sharp typography and a dark-light palette for effortless reading.



DELTA PYLONS
& DIRECTORIES

21



DELTA SIGNAGE LINE
PYLON



PYLON

The Cyber Pylon is a multi-tenant identification totem designed for commercial complexes, business parks, or mixed-use developments. Its sculpted silhouette and asymmetrical cuts give it a strong architectural character, standing out as both a branding element and a directional tool. Each tenant panel is framed with clarity and precision, allowing for quick brand recognition.



DELTA PYLON

22

DELTA SIGNAGE LINE
MAIN DIRECTORY



MAIN DIRECTORY

The Cyber Main Building Directory is a centerpiece wayfinding element crafted for lobbies, plazas, and circulation hubs. Featuring a frameless map display embedded in a sculpted, monolithic structure, it merges advanced form with practical clarity. This directory offers an at-a-glance overview of complex layouts while reinforcing a bold architectural identity.



**DELTA MAIN
DIRECTORY**

23

DELTA SIGNAGE LINE
DIGITAL DIRECTORY



DIGITAL DIRECTORY

The Cyber Indoor Digital Pylon is a cutting-edge directory system for high-traffic interior spaces. With a commanding vertical screen housed in a sculptural base, this unit merges real-time information display with the angular elegance of the Cyber line. Ideal for shopping centers, airports, corporate buildings, and universities, it provides dynamic content in a visually striking format.



**DELTA DIGITAL
DIRECTORY**

24

DELTA SIGNAGE LINE
PAINT COLORS

Paint Filled Graphics, Tipped Graphics, and Background Colors can be selected from the Standard Paint Colors options below:

(PANTONE®)

 Obsidian Black C	 Snow 000 C	 Coyote Brown 7553 C	 Urban Safari 7497 C
 Onyx Neutral Black C	 Espresso 4975 C	 Sandstone 7508 C	 Atmospheric 7540 C
 Storm 422 C	 Ozone 427 C	 Olive Hills 7536 C	 Alabaster 7506 C
 Cotton 7499 C	 Midnight 2767 C	 Island Cave 7687 C	 Yucatan 640 C
 Merlot 1815 C	 Royal Crimson 7622 C	 Inferno 485 C	 Shanghai Jade 340 C
 Jasper 171 C	<p>For custom colors, provide color code from standard color systems: pantone (PMS), Sherwin Williams, Benjamin Moore, RAL, Matthews, AkzoNobel (Grip-Gard), etc. Custom Color Charge: \$125 Metallics and other Variants: Extra Signage samples are available for additional charge, we highly recommend ordering additional samples for quality control.</p>		



SDI DELTA SIGNAGE LINE

CONTACT

HEADQUARTERS

250 Pehle Ave, Ste 200, Saddle Brook, NJ 07663

OFFICE

50 Harrison St, Ste 214, Hoboken, NJ 07030

FACTORY

213 Porter Rd, Conroe, TX 77301



www.sd-ind.com



sales@sd-ind.com



212-348-8000